

VGS-WHT-81953

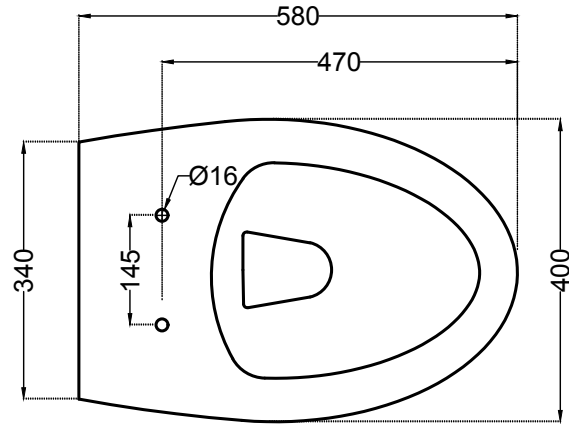

TOP VIEW

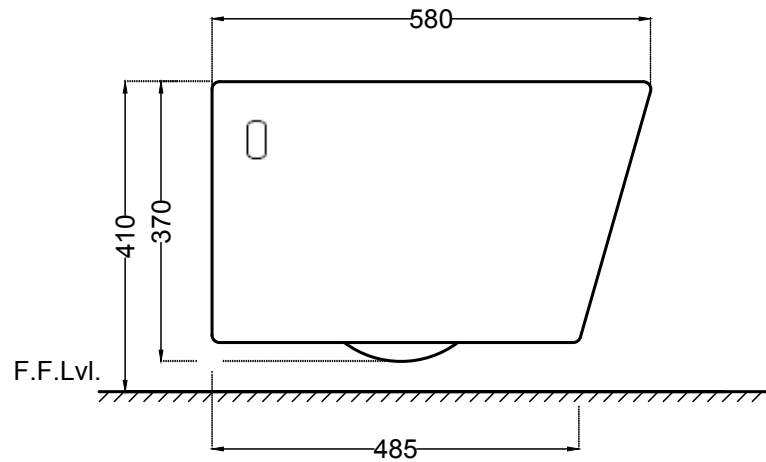

SIDE VIEW

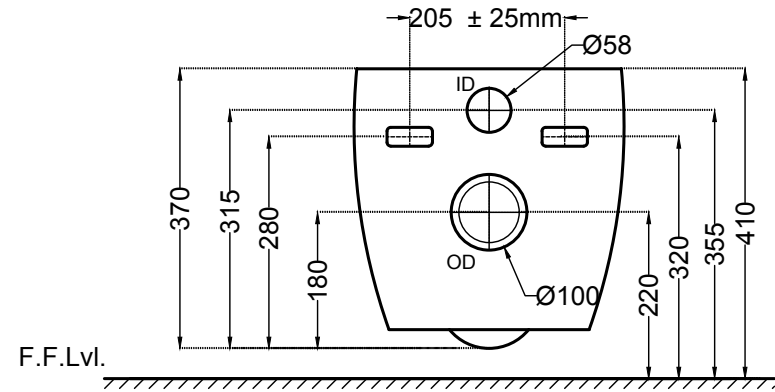

BACK VIEW

ALL DIMENSIONS ARE IN MM.
(TOLERANCE ± 5 MM)