

LYS-WHT-38853S

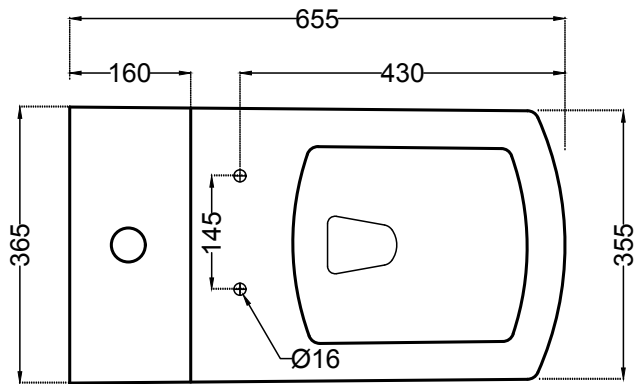

TOP VIEW

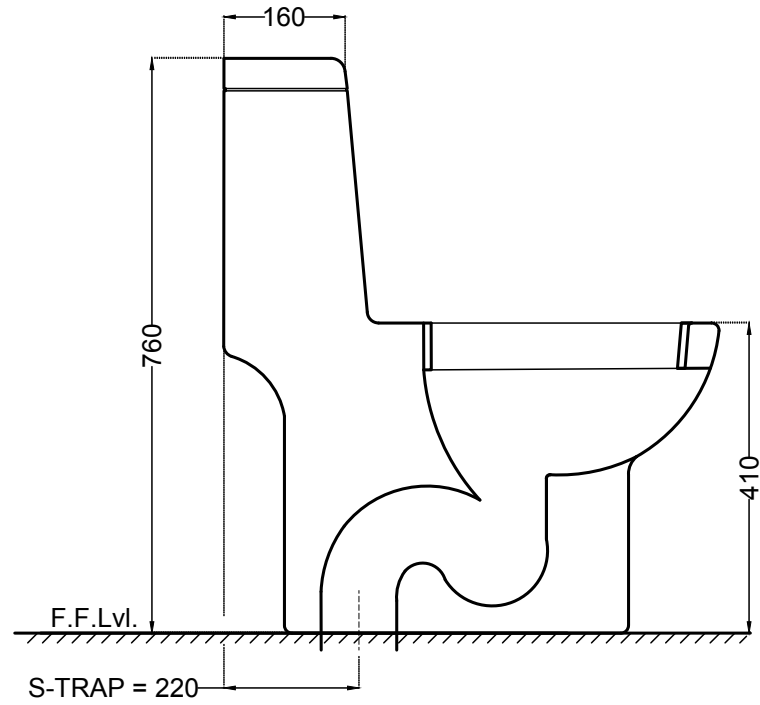

SIDE VIEW

ALL DIMENSIONS ARE IN MM.
(TOLERANCE ± 5 MM)